

BACKHOME^h

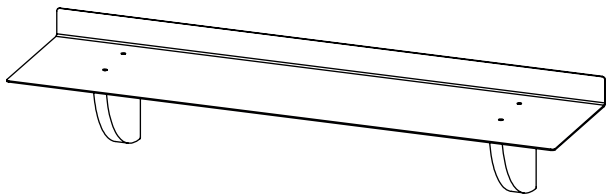

TRIVIA Shelf

ASSEMBLY INSTRUCTIONS

**PRODUCT INFORMATION | INFORMACIÓN DEL PRODUCTO
INFORMATION DU PRODUIT | INFORMAÇÃO DO PRODUTO**

EN	ES
Weight 5kg	Peso 5kg
Materials & Finishings Metal and 100% solid ash structure; Powder coating and oil with UV protection.	Materiales y Acabados Metal y fresno 100% macizo; Powder coating y aceite con protección UV.
Category Shelf	Catégorie Estante
Environment Indoor	Ambiente Interior
FR	PT
Poids 5kg	Peso 5kg
Matériaux et Finitions Métal et 100% frêne massif; Huile avec protection et UV revêtement en poudre.	Materiais e Acabamentos Metal e freixo 100% maciço; Powder coating e óleo com proteção UV.
Catégorie Étagère	Categoria Prateleira
Environnement Intérieur	Ambiente Interior

DIMENSIONS | DIMENSIONES | DIMENSIONS | DIMENSÕES

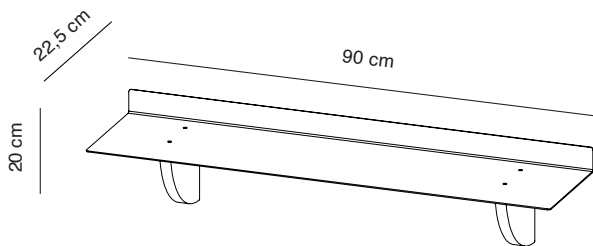

CONTENT | CONTENIDO | CONTENU | CONTEÚDO

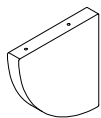

X2

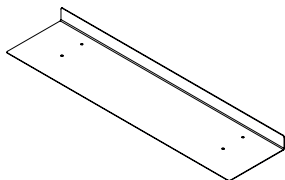

X1



X2



X2



X4

Additional tools needed to assemble the shelf.

Se necesitan herramientas adicionales para ensamblar el estante.

Outils supplémentaires nécessaires pour assembler l'étagère.

Ferramentas adicionais necessárias para montar a prateleira.

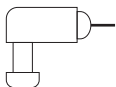

One person.

Una personas.

Une persona.

Uma pessoa.

ASSEMBLY INSTRUCTIONS | INSTRUCCIONES DE MONTAJE
INSTRUCIONS DE MONTAGE | INSTRUÇÕES DE MONTAGEM

1

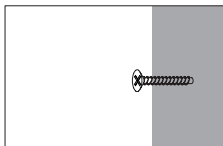
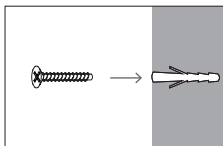
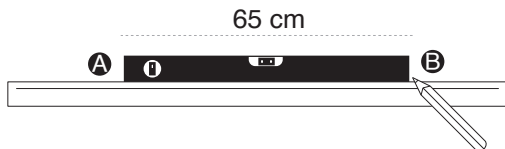

②

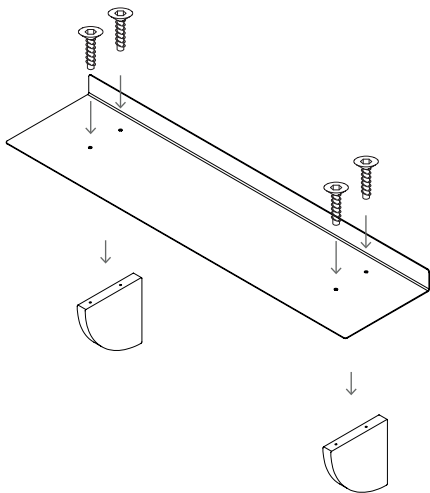

③

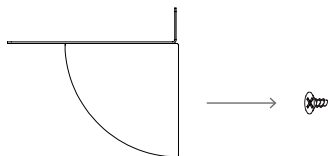



BACKHOME.ONLINE